



VISSEM ELECTRONICS CO., LTD

R&D DIVISION

262-14, Guseong-ro, Giheung-gu, Yongin-si,

Gyeonggi-do, 446-915, KOREA

TEL: +82-31-288-3427~29,20

FAX: +82-31-288-3490~1

[HTTP://WWW.VISSEM.COM](http://www.vissem.com)

LED DOT MATRIX MODULE

VL400T210-1

ISSUED DATE		2015.05.30	ITEM	DESIGN	CHECK	APPROVAL
VER	BV4.00	2015.05.30	SIGNATURE			
			DATE			

1. MODEL NAME : VL400T210-1

2. FEATURES

ITEM		DESCRIPTION
Display Color		Red, Pure Green, Amber
Shape		Quarter Of 400 X 400(mm) Module
Structure	Size(WXHXD)	200 X 200 X 27(mm)
	Dot Pitch	25(mm)
	Number Of Dots	64(8 × 8) Dots
	Leds Per Dot	R:2, PG:1
Weight		Max.0.62(kg)
Drive Mode		Static Drive
Application		Outdoor, Waterproof, Hood

3. ABSOLUTE MAXIMUM RATINGS

ITEM	SYMBOL	VALUE	UNIT	REMARK
Supply Voltage	V_{LED}	0~+5.5	V	
	V_{CC}	0~+6.0		
Signal Input Voltage Level	V_{IH}, V_{IL}	-0.3~ $V_{CC}+0.3$	V	
Operating Temperature	$T_{OP}^{[1]}$	-20 ~ +50	°C	On Dots=100%
		-20 ~ +60	°C	On Dots=30%
Storage Temperature	T_{stg}	-25 ~ +80	°C	

NOTES : [1] Temperature of led surface's should be remained below 70°C in case of necessity, led system requires cooling fan. Maintained at less than 80% relative humidity, and no dew condensation shall take place.

4. RECOMMENDABLE OPERATING CONDITIONS

ITEM		SYMBOL	MIN.	TYP.	MAX.	UNIT	REMARK
Supply Voltage	Led	V_{LED}	4.75	5	5.25	V	
	Logic Circuit	V_{CC}	4.75	5	5.25		
Signal Input Voltage Level	V_{IH}	$0.7 \times V_{CC}$	-	V_{CC}			
	V_{IL}	0	-	$0.3 \times V_{CC}$			
Operating Temperature		T_{OP}	-15 ~ +45			°C	

5. ELECTRICAL CHARACTERISTICS (AT $T_a = 25^\circ C$)

ITEM	SYMBOL	VALUE	UNIT	REMARK
Clock Frequency	F	MAX.16	MHz	
Current Consumption For 8X8Dot Module	I_{LED}	MAX. 2.8	A	ALL On
	I_{IC}	MAX. 0.5		

	MODEL	VERSION UPDATE	PAGE
	VL400T210-1	2015.05.30	1/12

6. OPTICAL CHARACTERISTICS(AT T_a = 25℃)

ITEM		SYMBOL	MIN.	TYP.	MAX.	UNIT	REMARK
Brightness	RED	L _v	3,000	-	-	cd/m ²	
	GREEN		2,900	-	-		
	AMBER		5,800	-	-		
Wavelength	RED	λ _p	620	-	628	nm	
	GREEN		519	-	527		
Viewing Angle	HOR.	2θ _{1/2}	-	110	-	deg(°)	Tolerance ±10%
	VER.		-	40	-		

[REFERENCE] **Brightness of standard model are measured by Our company's the controller.**
If you have any questions about brightness, Please contact us.

7. SIGNAL FUNTION

1) DATA SIGNAL CONNECTOR (※CAUTION : PIN PITCH OF DATA CONNECTOR IS 2.0mm)

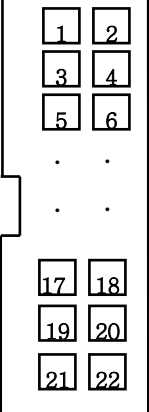
PIN MAP (IN)	PIN NUMBER	PIN NAME	FUNCTION DESCRIPTION
 <p>TOP VIEW</p>	1,7	RED0~RED1	DATA INPUT FOR RED COLOR
	3,9	GRN0~GRN1	DATA INPUT FOR GREEN COLOR
	5,11	NC	NOT CONNECTION
	13	LATCH	DATA STROBE
	15	\overline{ROE}	RED COLOR BRIGHTNESS CONTROL
	17	\overline{GOE}	GREEN COLOR BRIGHTNESS CONTROL
	19	NC	NOT CONNECTION
	21	SCLK	SHIFT CLOCK FOR INPUT DATA
	2,4,6,8,10,12, 14,16,18,20,22	GND	GROUND OF THE MODULE

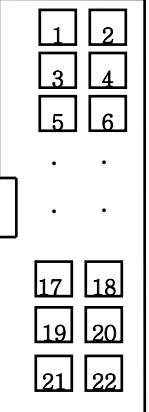
PIN MAP (OUT)	PIN NUMBER	PIN NAME	FUNCTION DESCRIPTION
 <p>TOP VIEW</p>	1,7	RED0~RED1	DATA OUTPUT FOR RED COLOR
	3,9	GRN0~GRN1	DATA OUTPUT FOR GREEN COLOR
	5,11	NC	NOT CONNECTION
	13	LATCH	DATA STROBE
	15	$\overline{ROE_OUT}$	RED COLOR BRIGHTNESS CONTROL
	17	$\overline{GOE_OUT}$	GREEN COLOR BRIGHTNESS CONTROL
	19	NC	NOT CONNECTION
	21	SCLK	SHIFT CLOCK FOR OUTPUT DATA
	2,4,6,8,10,12, 14,16,18,20,22	GND	GROUND OF THE MODULE

2) POWER CONNECTOR

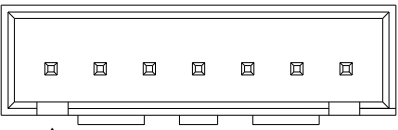
PIN MAP(POWER)	PIN NUMBER	PIN NAME	FUNCTION DESCRIPTION
 <p>No.1 TOP VIEW</p>	1,2,3	GND	Ground Of The Module
	4,5,6	V _{LED}	Supply Voltage For LED
	7	V _{CC}	Supply Voltage For IC

3) CONNECTOR CABLE SPECIFICATION

- DATA CABLE

22 PIN Cable (Pitch 2.00mm)

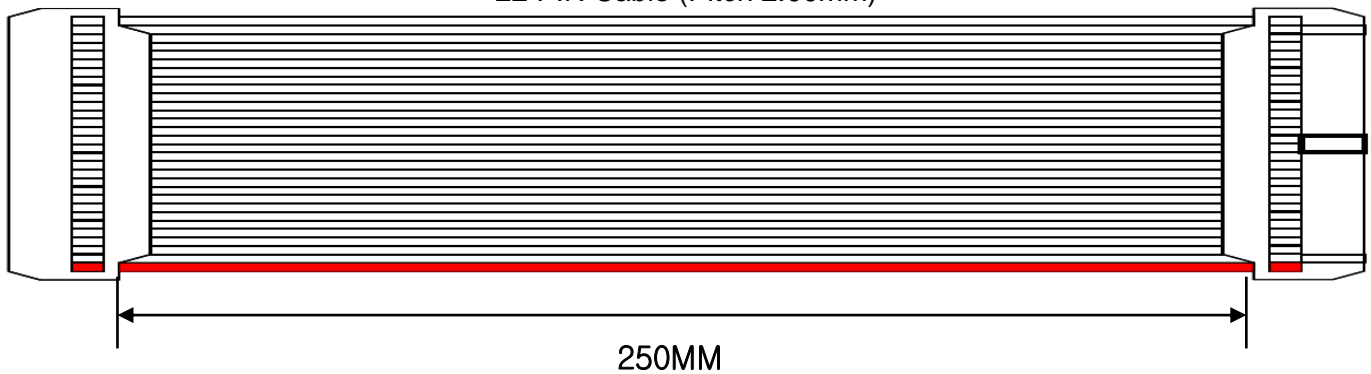

- POWER CABLE

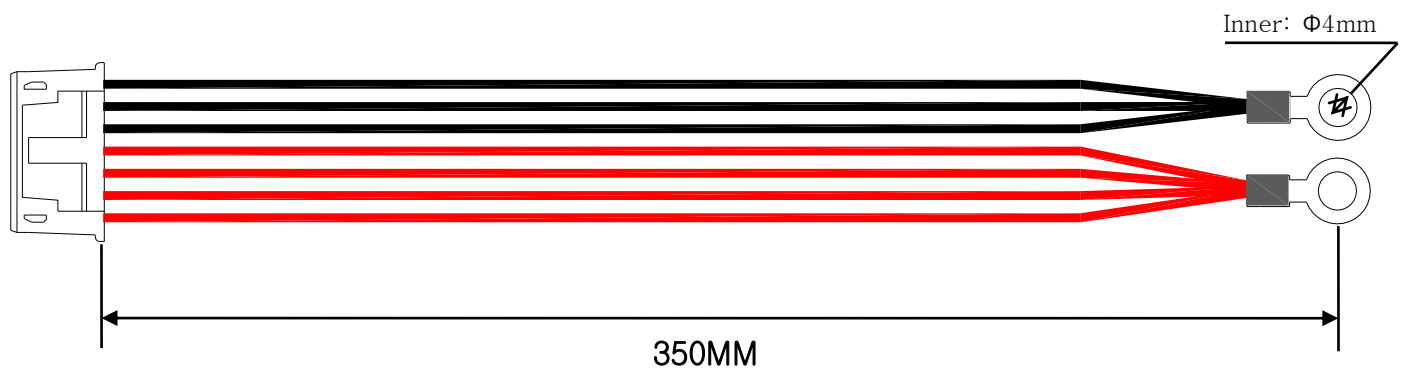

CONNECTOR	VENDOR	MODEL NO.	SPECIFICATION	HOUSING MODEL NO.
IN,OUT DATA	DONCONNECX	C05a-22ASA1-G	22PIN, 2mm PITCH	A05G-22BSA1-G102
POWER	GEOYOUNG	GWL250-07P	7PIN, 2.5mm PITCH	GHL250-07

※ This connectors can be changed without a previous notice for quality improvement.

	MODEL	VERSION UPDATE	PAGE
	VL400T210-1	2015.05.30	3/12

8. SIGNAL & POWER CABLE CONNECTION

1) DIRECTION OF DATA

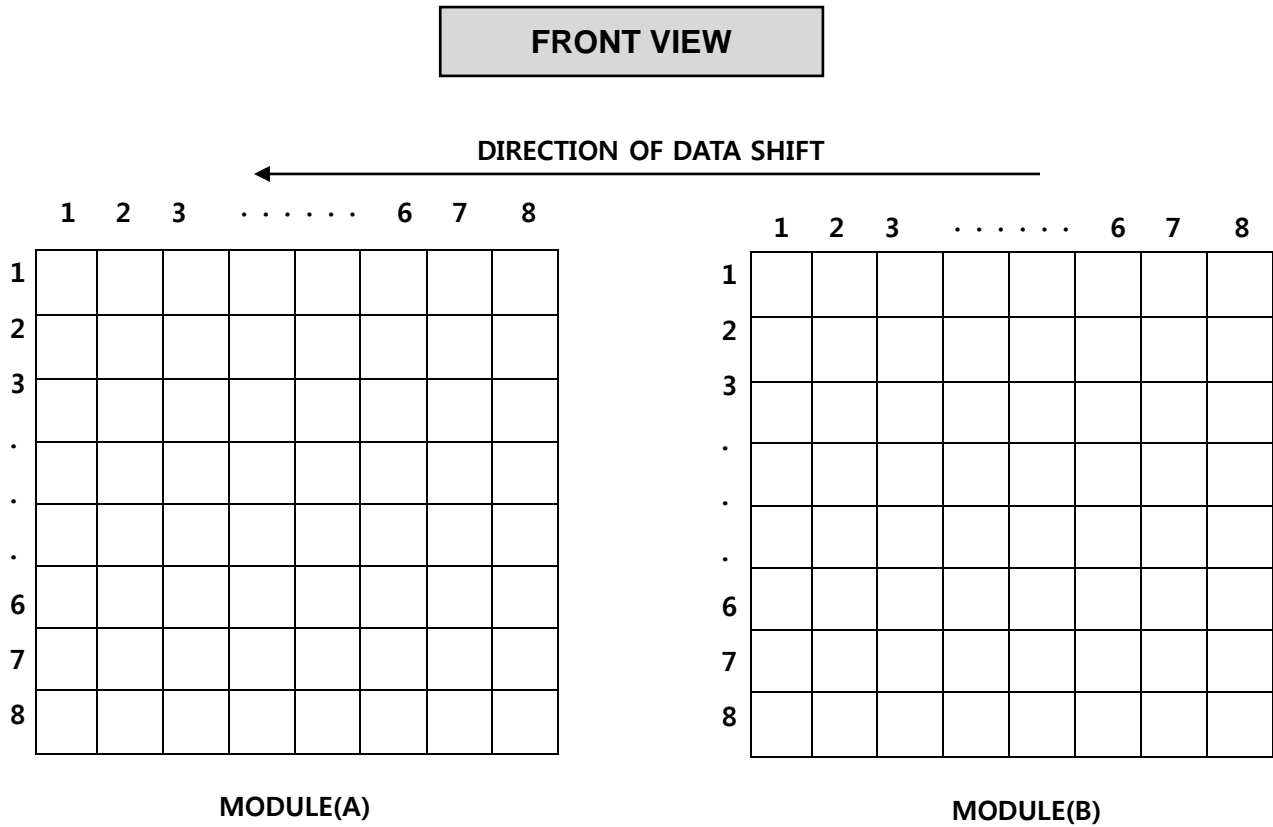

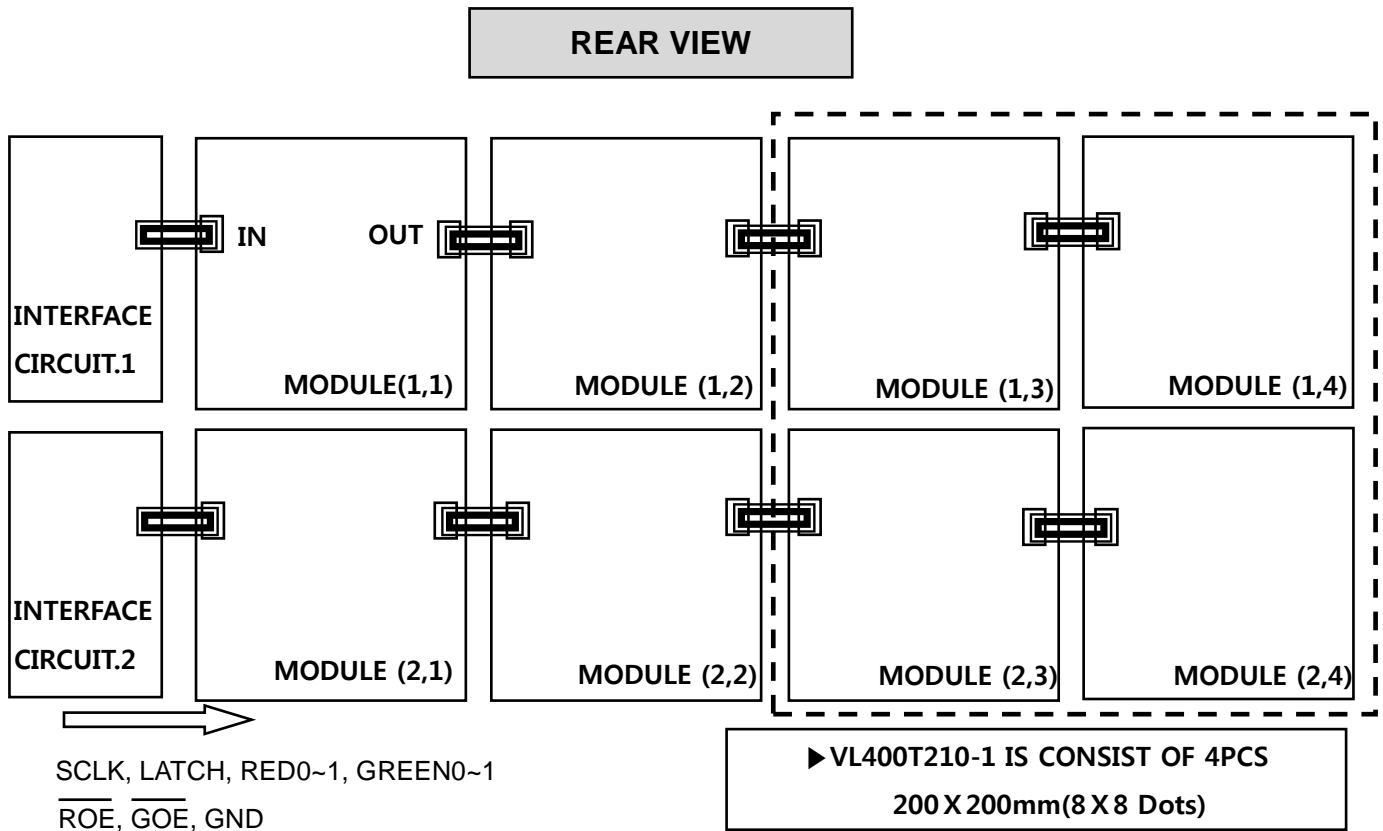

2) SIGNAL CABLE CONNECTION EXAMPLE

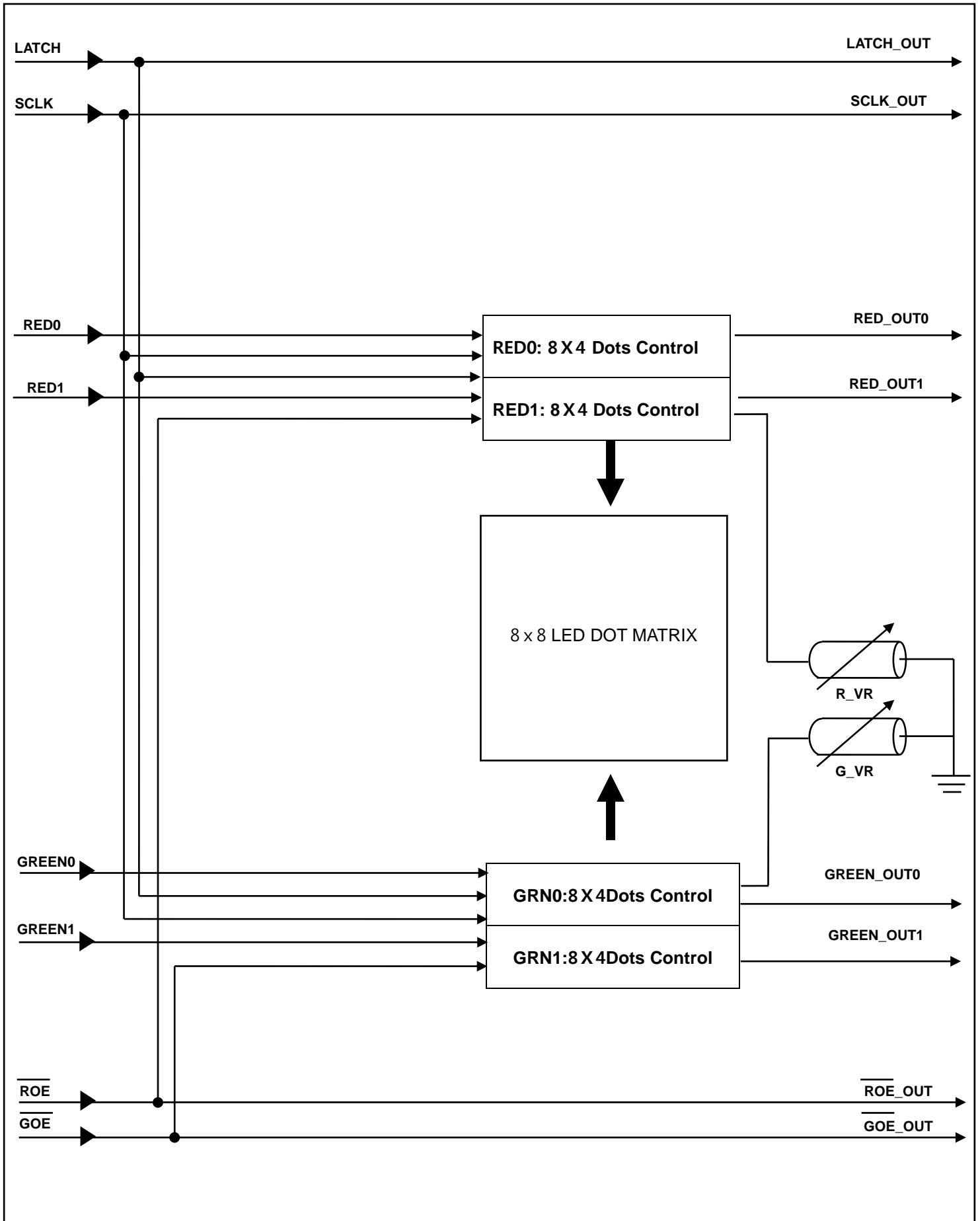

	MODEL	VERSION UPDATE	PAGE
	VL400T210-1	2015.05.30	4/12

9. BLOCK DIAGRAM



	MODEL	VERSION UPDATE	PAGE
	VL400T210-1	2015.05.30	5/12

10. TIMMING CHART

- DIRECTION OF DATA SHIFT

FRONT VIEW

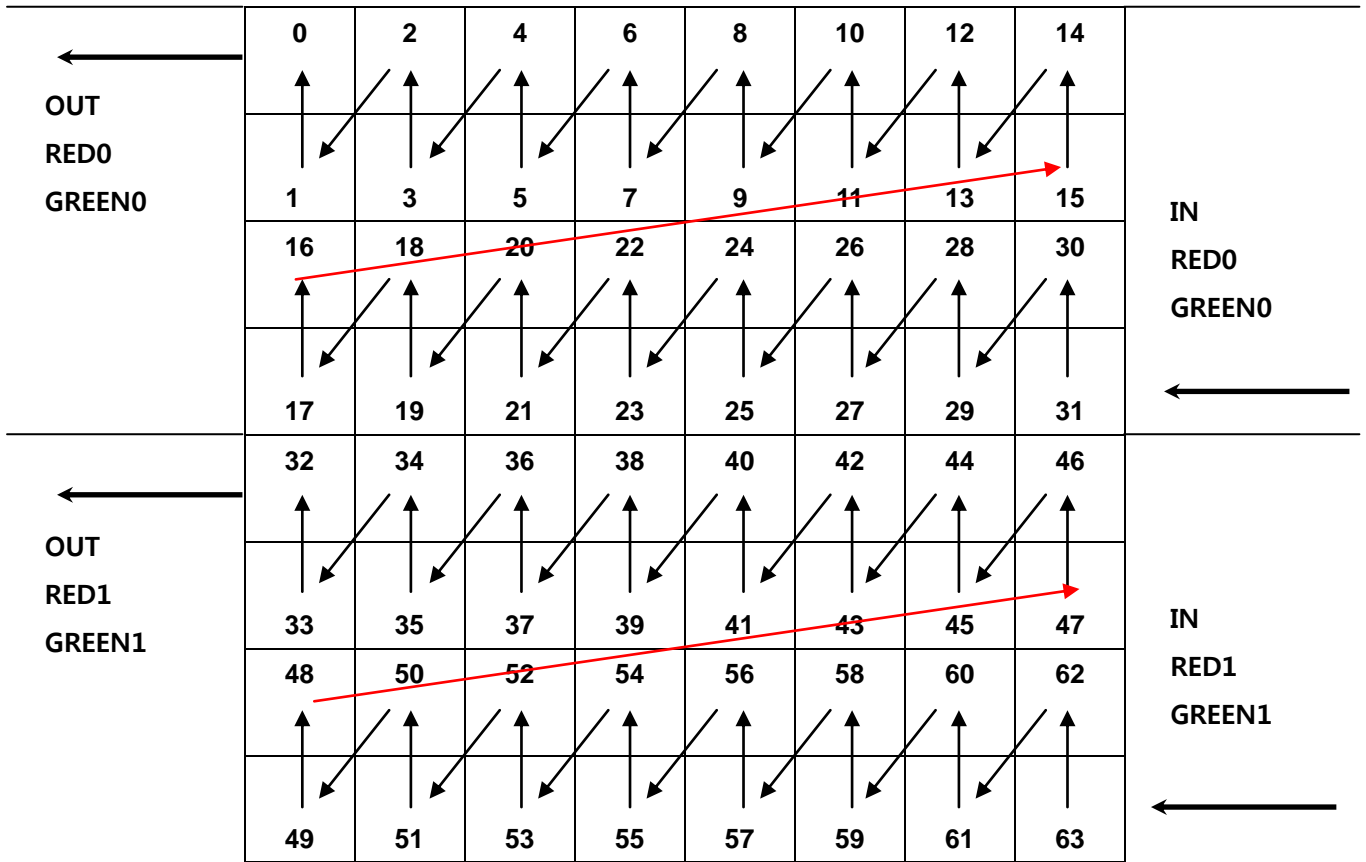

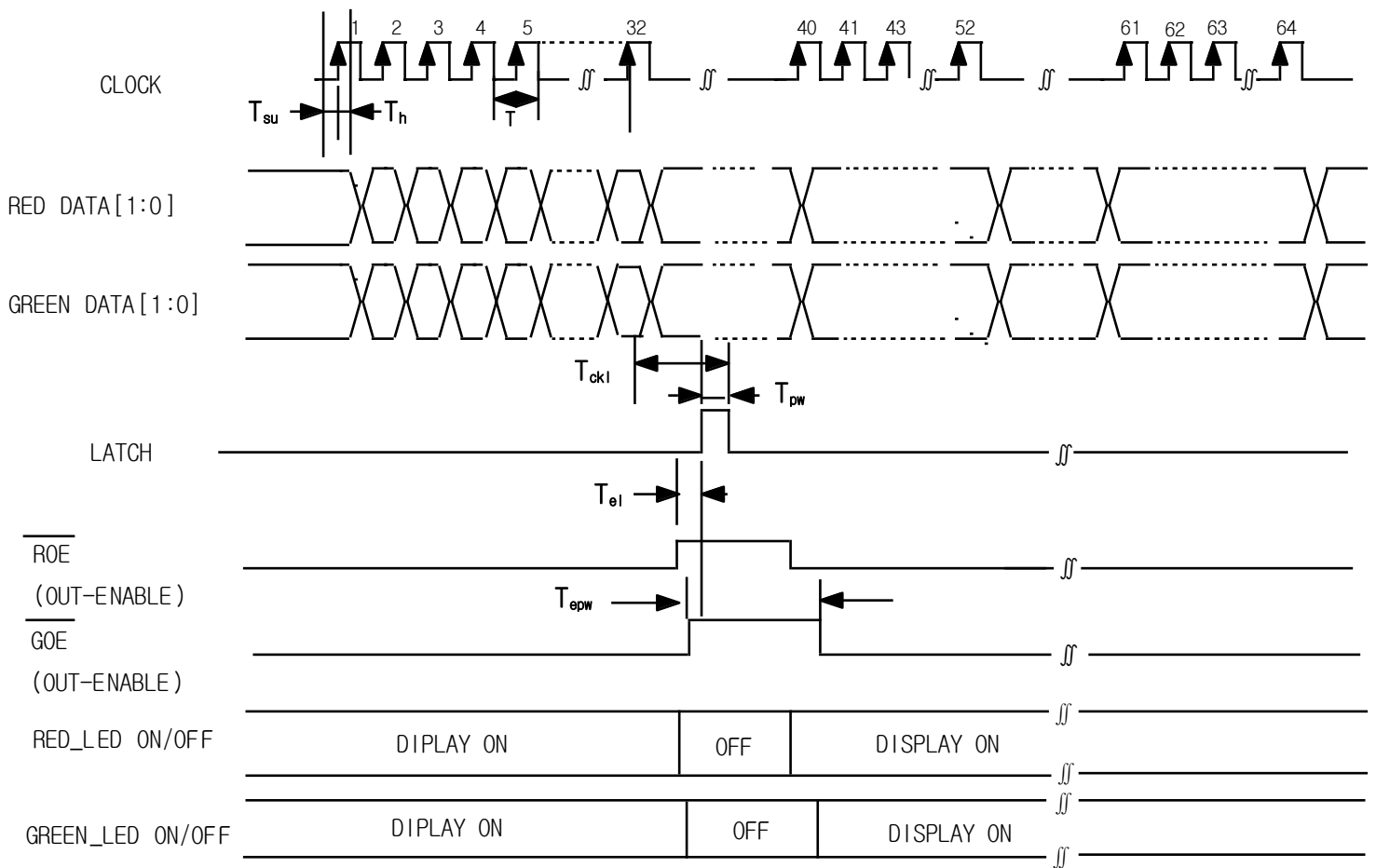

$V_{cc}=5V, T_a=25^{\circ}C$

CHARACTERISTICS	SYMBOL	MIN	MAX	UNIT
CLOCK CYCLE	T	-	16	MHz
DATA SETUP TIME	T_{su}	10	-	ns
DATA HOLD TIME	T_h	15	-	ns
LATCH PULSE WIDTH	T_{pw}	50	-	ns
LATCH HOLD TIME	T_{ckl}	15	-	ns
ENABLE-LATCH TIME	T_{el}	1	-	μs
ENABLE PULSE WIDTH	T_{epw}	3	-	μs

11. DIMENSION

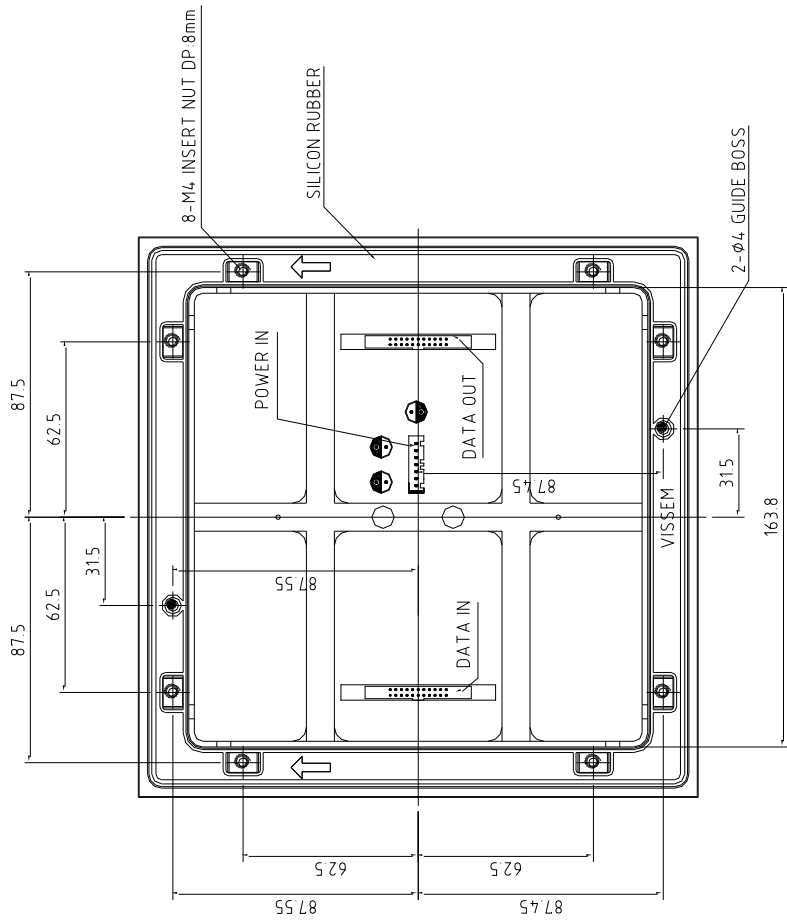

REAR VIEW

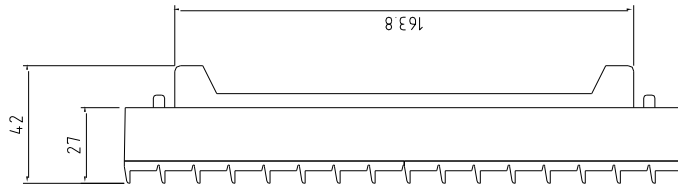

SIDE VIEW

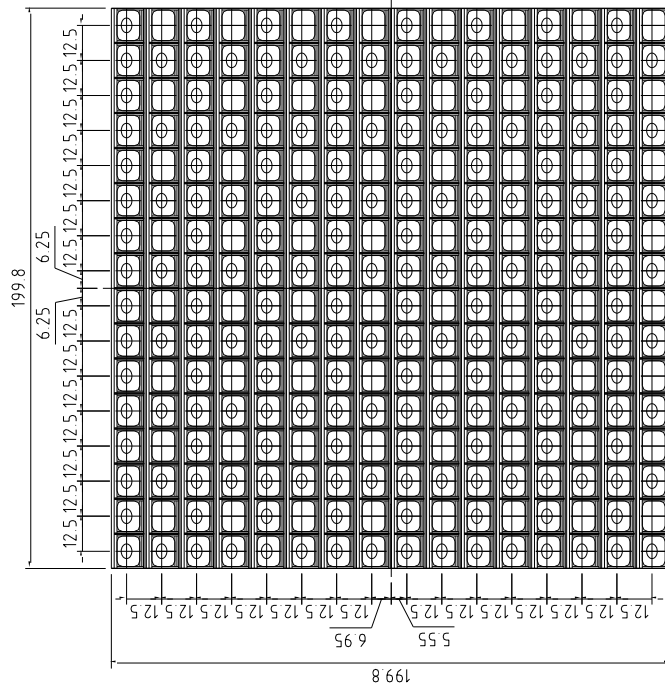

FRONT VIEW



	MODEL	VERSION UPDATE	PAGE
	VL400T210-1	2015.05.30	8/12

Plate Work

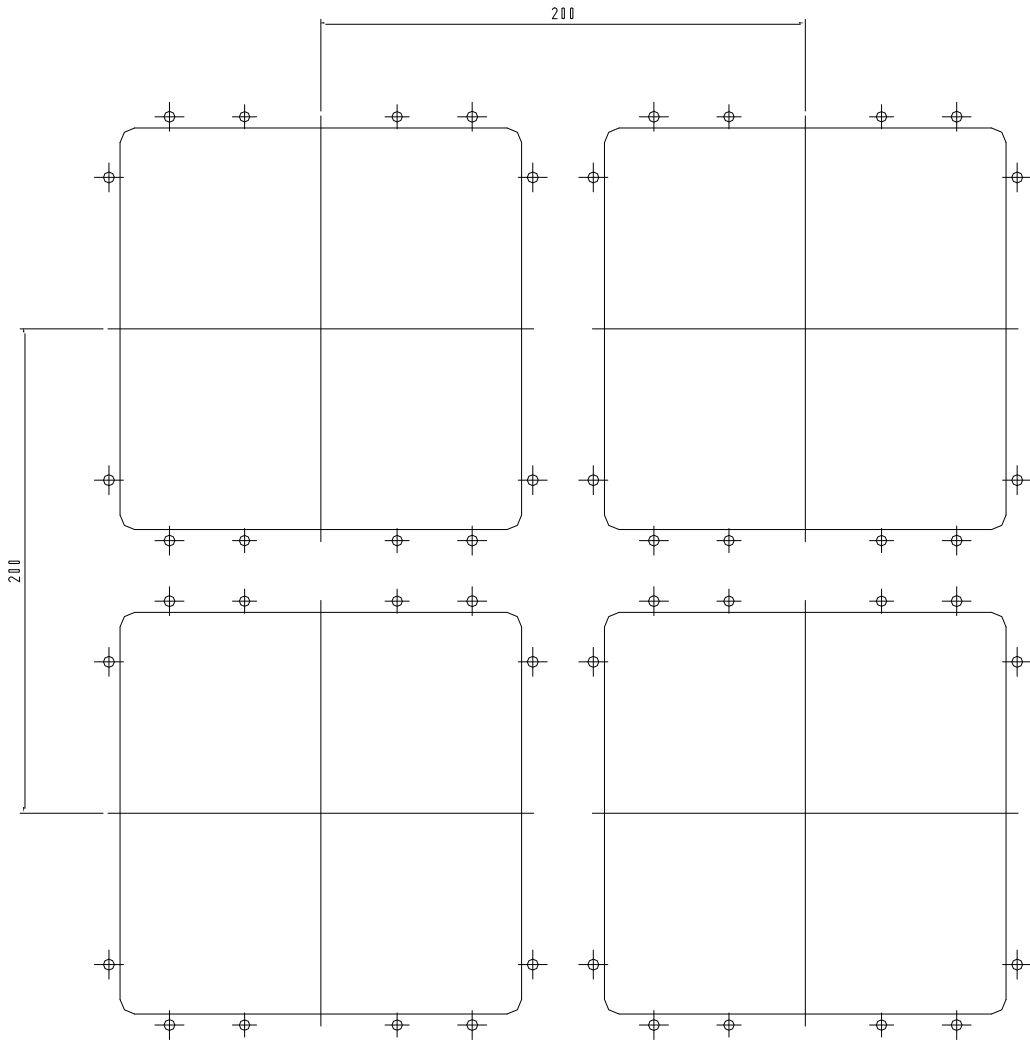
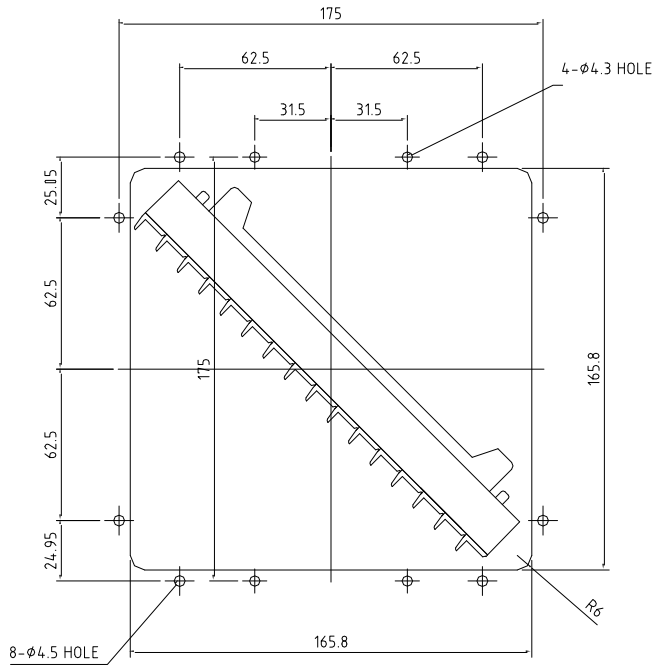

2By2 Array

	MODEL	VERSION UPDATE	PAGE
	VL400T210-1	2015.05.30	9/12

※ 제품 조립 시 주의 사항 ※

▶ 적정 토크 기준 : 6~7Kg/cm (토크눈금단위가 아니므로 주의 할 것)

1. 이 이상의 힘이 가해질 시 모듈의 사출물이 파손이 일어 날 수 있습니다.
2. 이 이하의 힘으로 조립 시 모듈사출물과 상대물이 압착이 안되어서 방수에 문제가 생길 수 있습니다.
3. 처음 1개 모듈을 적정토크 기준으로 조립 하시고 손 드라이버로 반드시 확인하여 주시기 바랍니다. 확인 후 이상이 없으시면 나머지 모듈을 같은 토크로 조립하시고 이상이 있을 시 적정 토크를 다시 조정하여 확인 후 조립 하시기 바랍니다.

→ 시간이 지남 또는 사용빈도 수에 따라 전동드라이버의 토크가 약해지므로 전동드라이버의 설명서에 적혀 있는 토크가 실제와 차이가 있을 수 있으니 반드시 손 드라이버로 볼트의 조임 상태를 확인 하시기 바랍니다.

※ Matters that require attention during assembling work ※

▶ Standard for optimal torque : 6~7Kg/cm (Beware of torque marking unit)

1. When more force applies than this standard, all molding could be damaged.
 2. When less force applies than this standard, water proof problem would be caused because all moldings and their facing objects cannot adhere to each other properly.
 3. Assembly first 1 module following to standard for optimal torque. And, check it with hand driver.
 - If there is no problem, use same way for others.
 - When any problem comes out, adjust standard for optimal torque and try again.
- Due to the time advanced or the amount used, torque of electric driver would become weaken. So, check tightening condition with hand driver because there would be the gap between torque described at manual and actual torque.

	MODEL	VERSION UPDATE	PAGE
	VL400T210-1	2015.05.30	10/12

12. SAFETY

● Precautions in installing LED Module

1. Please escape the place where electromagnetic wave and noise is, which might cause malfunction to LED module, when install LED Display Board.
2. Since over voltage and reverse voltage might cause the problem in internal circuit and LED, please make sure and check the input voltage range, before operation.
3. Please escape the high humidity and leakage place which cause the LED module to be broken.
4. The temperature of the surface of LED module shall be under 70°C during operation.
5. Heating from LED might cause damage in LED module or/and malfunction in LED display board, user shall prepare suitable ventilation and cooling facility.
6. Even though the brightness become lower and lower, after long time use, it's prohibited to input over voltage in order to increase the brightness, which might cause severe damage to LED Module.
For the best operation, user shall operate LED module according to data sheet.
7. Please turn off the power supply, when display data are not charged.
8. Please be careful not to exposure LED Module to the dust, dirt, base, gas and other noxious gas, when install LED Display.
9. User shall consider the weight of LED module enough, when prepare steel structure and install LED Display Board.

	MODEL	VERSION UPDATE	PAGE
	VL400T210-1	2015.05.30	11/12

● Precautions in installing LED Module

1. Any jumper and switch is set up properly before delivery, please do not modify or/and change setting without consulting with manufacturer.
2. The circuit part of LED Module includes CMOS components, please treat carefully with consideration of static electricity
3. Impact and vibration to LED Module might be the reason of disconnection and dot off, please escape those factors.
4. It's highly recommended to escape the high temperature & humidity and be careful not to exposure LED module to dust, dirt, base and SO2 Gas and other noxious Gas in order to escape the potential problem.
5. Please be careful not to be scratched and hurt on the surface of LED module.
6. It's prohibited to clean up LED module with solvent.
In order to clean up LED module, it's highly recommended to use a piece of dried cloth and smooth brush.
7. Stacking LED modules without anti-impact material and wearing out the surface or/and edge of LED modules might cause fatal problem.
8. It's highly recommended to use twisted cable or shielded wire in order to remove the noise from high frequency.
9. When user use and store LED module, please pack LED module with anti-static material.

WWW.VISSEM.COM

	MODEL	VERSION UPDATE	PAGE
	VL400T210-1	2015.05.30	12/12