



VISSEM ELECTRONICS CO., LTD

R&D DIVISION

262-14, Guseong-ro, Giheung-gu, Yongin-si,

Gyeonggi-do, 446-915, KOREA

TEL: +82-31-288-3427~9

FAX: +82-31-288-3490~1

[HTTP://WWW.VISSEM.COM](http://www.vissem.com)

LED DOT MATRIX MODULE

VS064F111-8

2 x 1 Type

ISSUED DATE			ITEM	DESIGN	CHECK	APPROVAL
VER	A1V3.00		SIGNATURE			
			DATE			

1. MODEL NAME : VS064F111-8

2. FEATURES

ITEM		DESCRIPTION
Display Color		Full Color
Structure	Size(W X H X D)	128 X 64 X17.5(mm)
	Dot Pitch	4(mm)
	Number Of Dots	512(32 × 16) Dots
	Leds Per Dot	R:1, PG:1,B:1 (3In-1 SMD CHIP)
Weight		Max. 65 (g)
Drive Mode		1/8 Duty Drive
Application		INDOOR

3. ABSOLUTE MAXIMUM RATINGS

ITEM	SYMBOL	VALUE	UNIT	REMARK
Supply Voltage	V_{LED}	0~+5.5	V	
	V_{CC}	0~+6.0		
Signal Input Voltage Level	V_{IH}, V_{IL}	-0.3~ $V_{CC}+0.3$	V	
Operating Temperature	$T_{OP}^{[1]}$	-20 ~ +50	°C	On Dots=100%
		-20 ~ +60	°C	On Dots=30%
Storage Temperature	T_{stg}	-20 ~ +80	°C	

NOTES : [1] Temperature of led surface's should be remained below 70°C in case of necessity, led system requires cooling fan. Maintained at less than 80% relative humidity, and no dew condensation shall take place.

4. RECOMMENDABLE OPERATING CONDITIONS

ITEM		SYMBOL	MIN.	TYP.	MAX.	UNIT	REMARK
Supply Voltage	Led	V_{LED}	4.75	5	5.25	V	
	Logic Circuit	V_{CC}	4.75	5	5.25		
Signal Input Voltage Level	V_{IH}	$0.8 \times V_{CC}$	-	V_{CC}	$0.3 \times V_{CC}$		
	V_{IL}	0	-				
Operating Temperature		T_{OP}	0~35			°C	

5. ELECTRICAL CHARACTERISTICS (AT $T_a = 25^\circ\text{C}$)

ITEM	SYMBOL	VALUE	UNIT	REMARK
Clock Frequency	F	MAX.16	Mhz	
Current Consumption For Module	I_{LED}	MAX. 2.0	A	ALL On
	I_{IC}	MAX. 0.5		

	MODEL	VERSION UPDATE	PAGE
	VS064F111-8	2017.12.27	1/10

6. OPTICAL CHARACTERISTICS(AT T_a = 25°C)

ITEM		SYMBOL	MIN.	TYP.	MAX.	UNIT	REMARK
Brightness	RED	L _v	-	850	-	cd/m ²	
	GREEN		-	2,400	-		
	BLUE		-	250	-		
	WHITE		-	3,500	-		
Wavelength	RED	λ _p	620	-	630	nm	
	GREEN		523	-	532		
	BLUE		465	-	475		
Viewing Angle	HOR.	2θ _{1/2}	-	110	-	deg(°)	Tolerance ±10%
	VER.		-	110	-		

[REFERENCE] **Brightness of standard model are measured by Our company's the controller.**
If you have any questions about brightness, Please contact us.

7. SIGNAL FUNTION

1) DATA SIGNAL CONNECTOR

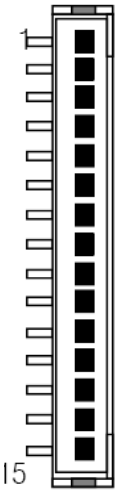
PIN MAP (IN)	PIN NUMBER	PIN NAME	FUNCTION DESCRIPTION
	1, 12	RED0, RED1	Data Input For Red Color
	2, 13	GRN0, GRN1	Data Input For Green Color
	11, 14	BLUE0, BLUE1	Data Input For Blue Color
	3[LSB], 4, 5[MSB]	A[0:2]_IN	3 BIT Line Address
	7	$\overline{\text{OE}}$	Color Brightness Control
	8	LATCH_IN	Data Strobe
	9	SCLK_IN	Shift Clock For Input Data
	15	DIS	Line Decoder Enable Signal
	6, 10	GND	Ground Of The Module

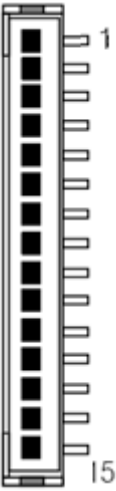
PIN MAP (OUT)	PIN NUMBER	PIN NAME	FUNCTION DESCRIPTION
	1, 12	RED0, RED1	Data Output For Red Color
	2, 13	GRN0, GRN1	Data Output For Green Color
	11, 14	BLUE0, BLUE1	Data Output For Blue Color
	3[LSB], 4, 5[MSB]	A[0:2]_OUT	3 BIT Line Address
	7	$\overline{\text{OE}}$	Color Brightness Control
	8	LATCH_OUT	Data Strobe
	9	SCLK_OUT	Shift Clock For Output Data
	15	DIS	Line Decoder Enable Signal
	6, 10	GND	Ground Of The Module

	MODEL	VERSION UPDATE	PAGE
	VS064F111-8	2017.12.27	2/10

2) POWER CONNECTOR

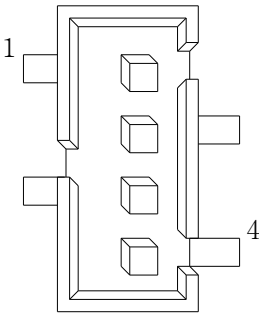
PIN MAP(POWER)	PIN NUMBER	PIN NAME	FUNCTION DESCRIPTION
	1, 2	$V_{CC} + V_{LED}$	Supply Voltage For IC & LED
	3, 4	GND	Ground Of The Module

3) CONNECTOR CABLE SPECIFICATION

- DATA CABLE



※ CAUTION : There is no need for data cable to connect in between modules. Only, there is need for data cable to connect between controller and module. The data cable's length depend on customer's condition

- POWER CABLE

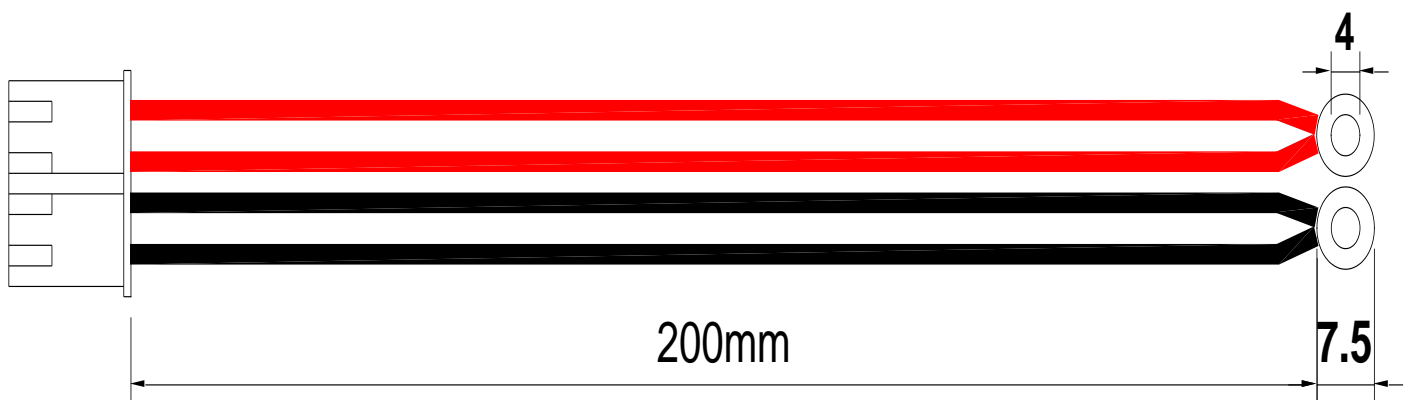

※ This connectors can be changed without a previous notice for quality improvement.

	MODEL	VERSION UPDATE	PAGE
	VS064F111-8	2017.12.27	3/10

8. SIGNAL & POWER CABLE CONNECTION

1) DIRECTION OF DATA

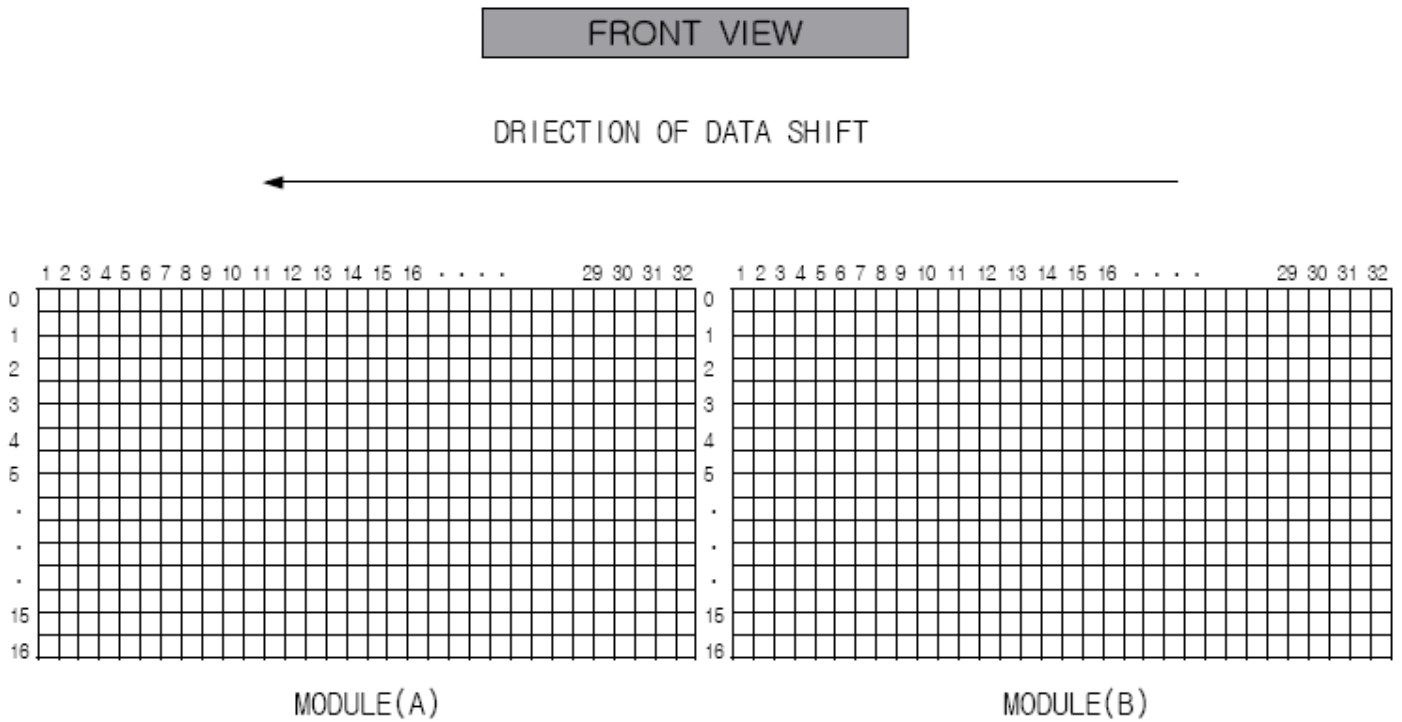

2) SIGNAL CABLE CONNECTION EXAMPLE

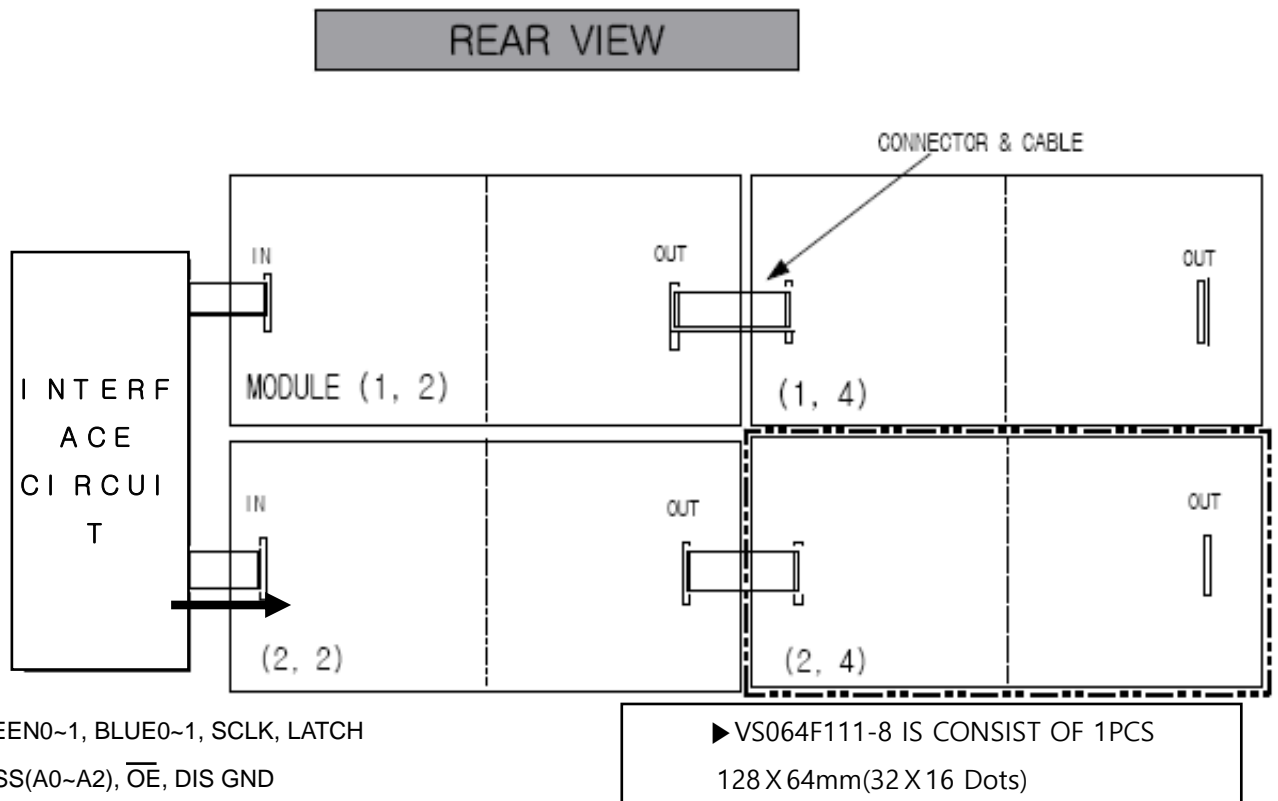

	MODEL	VERSION UPDATE	PAGE
	VS064F111-8	2017.12.27	4/10

9. BLOCK DIAGRAM

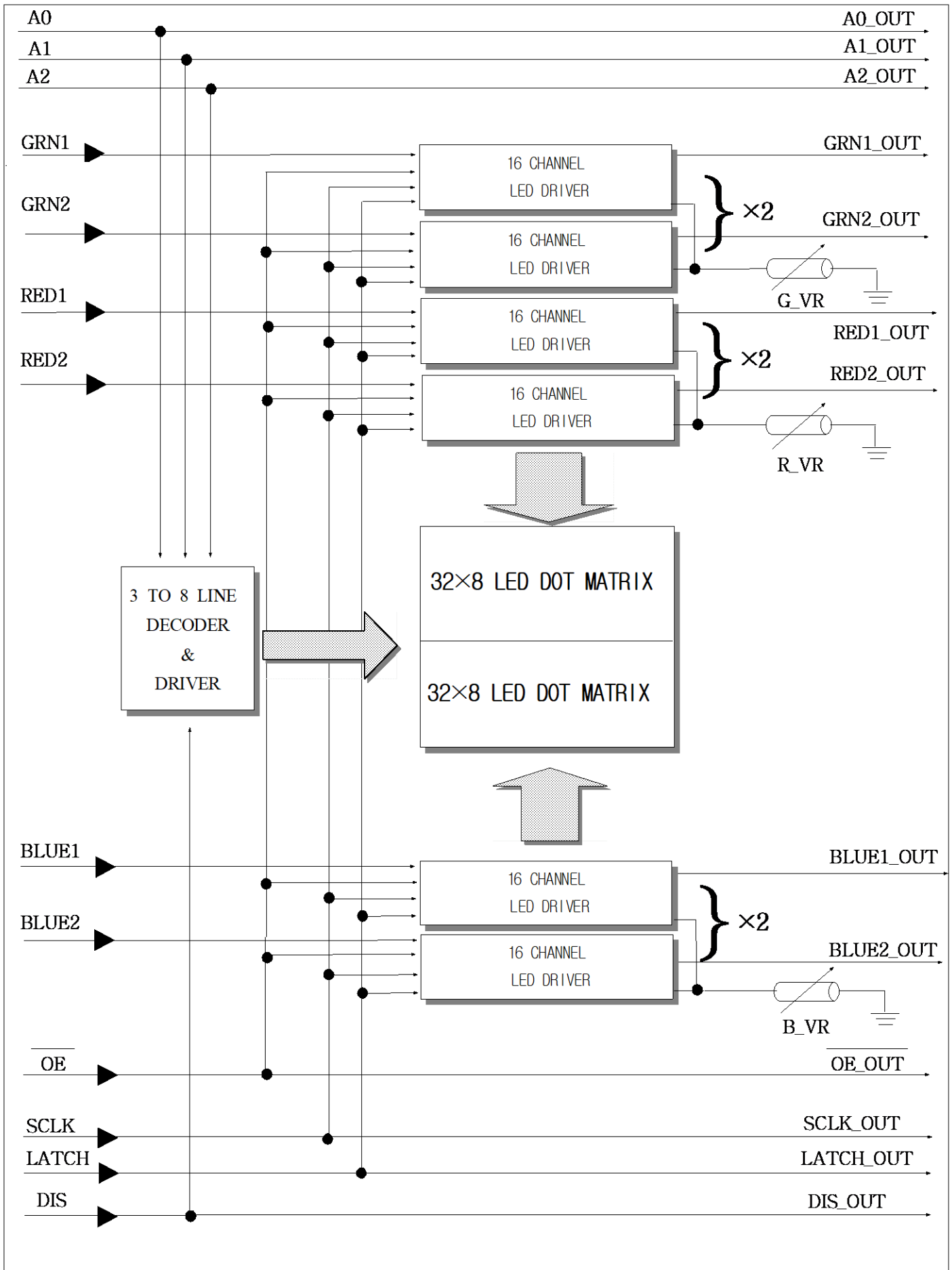

10. TIMMING CHART

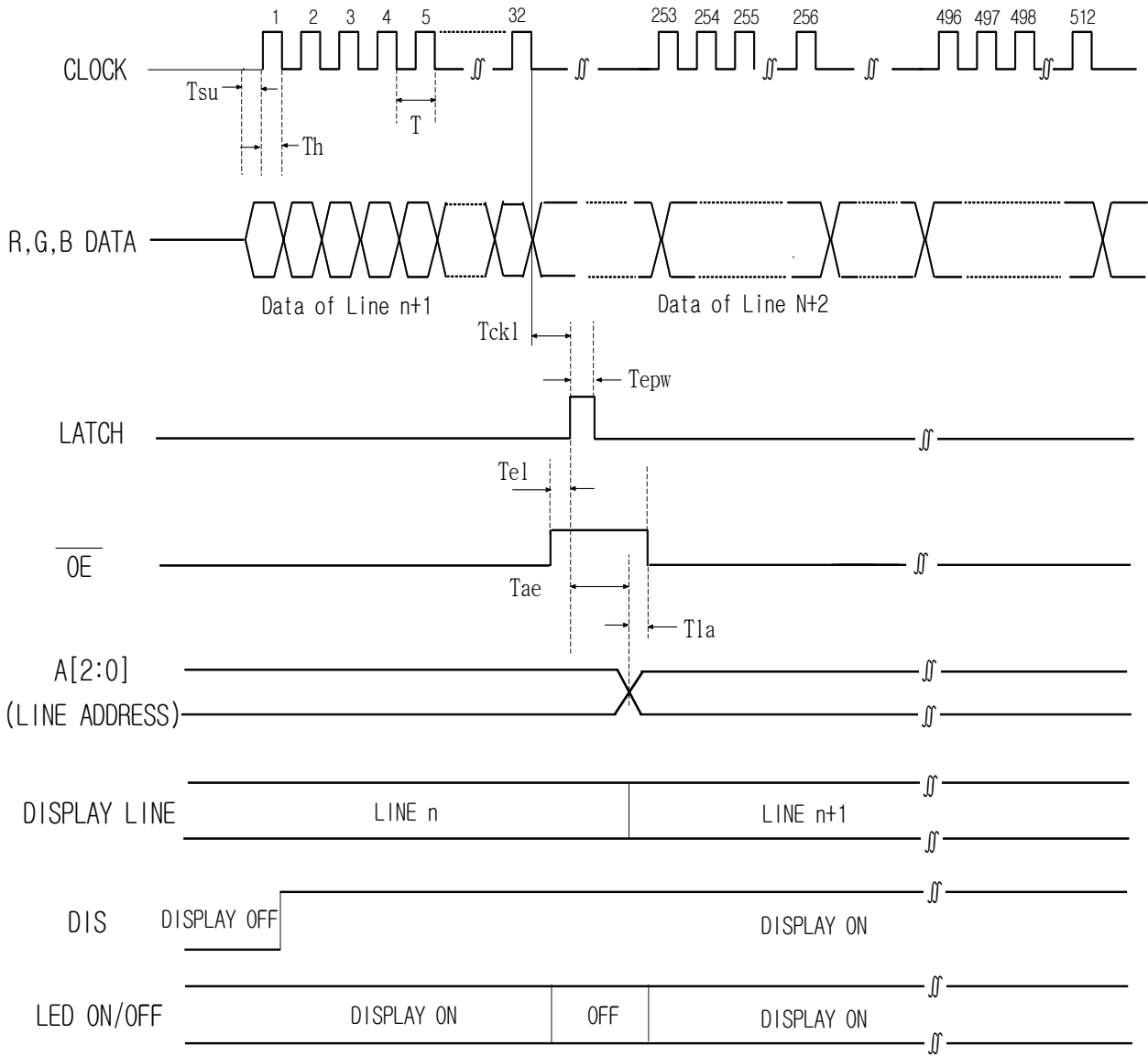

($T_a=25^{\circ}\text{C}, V_{CC}=5\text{V}$)

CHARACTERISTICS	SYMBOL	MIN.	MAX.	UNIT
CLOCK CYCLE	T	-	16	MHz
DATA SETUP TIME	T_{su}	10	-	ns
DATA HOLD TIME	T_h	15	-	ns
LATCH PULSE WIDTH	T_{pw}	50	-	ns
LATCH HOLD TIME	T_{ckl}	15	-	ns
ENABLE-LATCH TIME	T_{el}	1	-	us
ENABLE PULSE WIDTH	T_{epw}	3	-	us
ADDRESS-ENABLE TIME	T_{ae}	1	-	us
LATCH-ADDRESS TIME	T_{la}	20	-	ns

11. DIMENSION

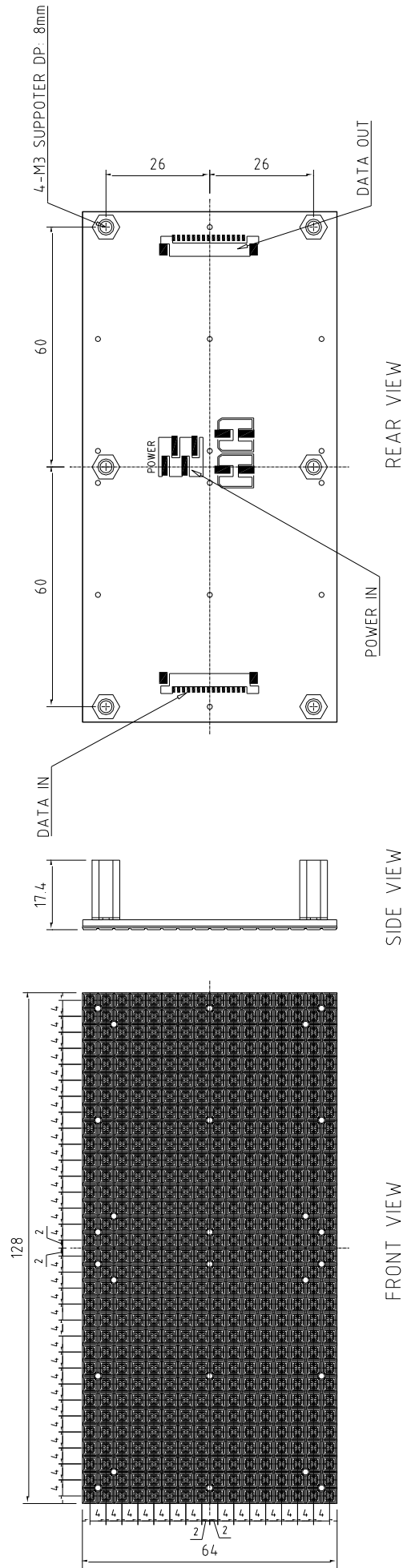



	MODEL	VERSION UPDATE	PAGE
	VS064F111-8	2017.12.27	7/10

Plate Work

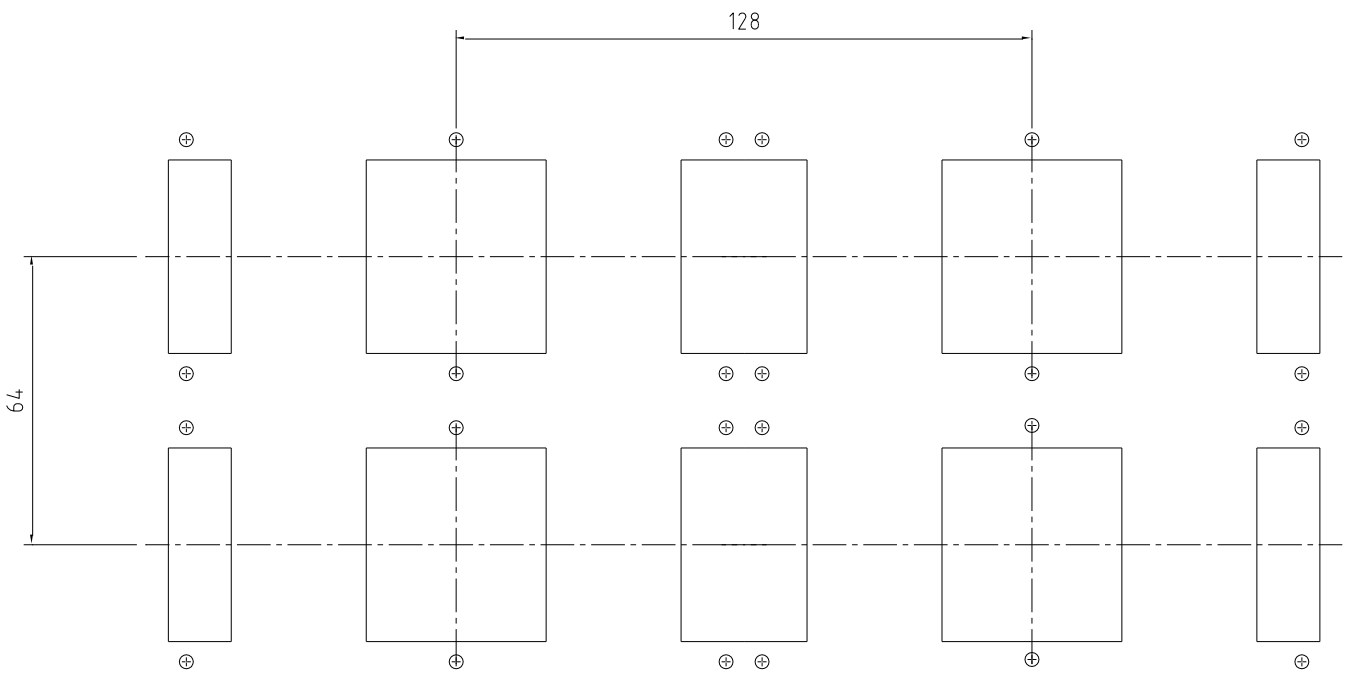
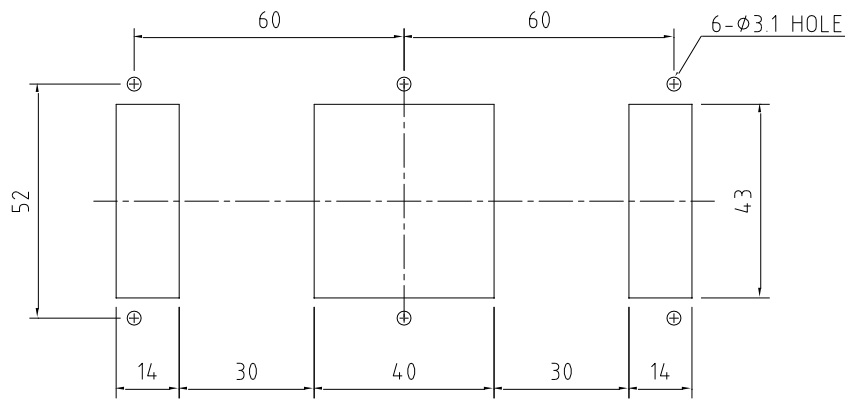

2*2 ARRAY

**** Hole for assemble between unit case and module.**

	MODEL	VERSION UPDATE	PAGE
	VS064F111-8	2017.12.27	8/10

12. SAFETY

● Precautions in installing LED Module

1. Please escape the place where electromagnetic wave and noise is, which might cause malfunction to LED module, when install LED Display Board.
2. Since over voltage and reverse voltage might cause the problem in internal circuit and LED, please make sure and check the input voltage range, before operation.
3. Please escape the high humidity and leakage place which cause the LED module to be broken.
4. The temperature of the surface of LED module shall be under 70°C during operation.
5. Heating from LED might cause damage in LED module or/and malfunction in LED display board, user shall prepare suitable ventilation and cooling facility.
6. Even though the brightness become lower and lower, after long time use, it's prohibited to input over voltage in order to increase the brightness, which might cause severe damage to LED Module.
For the best operation, user shall operate LED module according to data sheet.
7. Please turn off the power supply, when display data are not charged.
8. Please be careful not to exposure LED Module to the dust, dirt, base, gas and other noxious gas, when install LED Display.
9. User shall consider the weight of LED module enough, when prepare steel structure and install LED Display Board.

	MODEL	VERSION UPDATE	PAGE
	VS064F111-8	2017.12.27	9/10

● Precautions in installing LED Module

1. Any jumper and switch is set up properly before delivery, please do not modify or/and change setting without consulting with manufacturer.
2. The circuit part of LED Module includes CMOS components, please treat carefully with consideration of static electricity
3. Impact and vibration to LED Module might be the reason of disconnection and dot off, please escape those factors.
4. It's highly recommended to escape the high temperature & humidity and be careful not to exposure LED module to dust, dirt, base and SO2 Gas and other noxious Gas in order to escape the potential problem.
5. Please be careful not to be scratched and hurt on the surface of LED module.
6. It's prohibited to clean up LED module with solvent.
In order to clean up LED module, it's highly recommended to use a piece of dried cloth and smooth brush.
7. Stacking LED modules without anti-impact material and wearing out the surface or/and edge of LED modules might cause fatal problem.
8. It's highly recommended to use twisted cable or shielded wire in order to remove the noise from high frequency.
9. When user use and store LED module, please pack LED module with anti-static material.

WWW.VISSEM.COM

	MODEL	VERSION UPDATE	PAGE
	VS064F111-8	2017.12.27	10/10